

# TRD-J Series Incremental Encoders

## ■ Features

- Long-lasting design of ø8mm shaft in ø50mm body.
- Durable metal slit plate.
- Protection degree IP50 (dust proof) or IP65 (dust and splash proof).
- Wide voltage ranging from 4.75 to 30 VDC.



## ■ List of model numbers

Type	Appearance	Model number	Output	Pulse / revolution
With rear cable		TRD-J□-S	One-phase	10 30 40 50 60 100 120 200 240 300 360 400 500 600 750 1000  * 10 pulse is only available with one-phase
		TRD-J□-RZ	Two-phase with home position in normal operation	
		TRD-J□-RZL	Two-phase with home position in reverse operation	
		TRD-J□-RZV	Two-phase with home position and line driver	
Dust and splash proofed		TRD-J□-SW	One-phase	
		TRD-J□-RZW	Two-phase with home position in normal operation	
		TRD-J□-RZWL	Two-phase with home position in reverse operation	
		TRD-J□-RZVW	Two-phase with home position and line driver	
With connector		TRD-J□-SC	One-phase	
		TRD-J□-RZC	Two-phase with home position in normal operation	
		TRD-J□-RZCL	Two-phase with home position in reverse operation	
		TRD-J□-RZVC	Two-phase with home position and line driver	
Dust and splash proofed with connector		TRD-J□-SCW	One-phase	
		TRD-J□-RZCW	Two-phase with home position in normal operation	
		TRD-J□-RZCWL	Two-phase with home position in reverse operation	
		TRD-J□-RZVCW	Two-phase with home position and line driver	
With side cable		TRD-J□-SS <small>Note 1</small>	One-phase	
		TRD-J□-RZS <small>Note 1</small>	Two-phase with home position in normal operation	
		TRD-J□-RZSL <small>Note 1</small>	Two-phase with home position in reverse operation	
		TRD-J□-RZVS <small>Note 1</small>	Two-phase with home position and line driver	
Dust and splash proofed with side cable		TRD-J□-SWS <small>Note 1</small>	One-phase	
		TRD-J□-RZWS <small>Note 1</small>	Two-phase with home position in normal operation	
		TRD-J□-RZWSL <small>Note 1</small>	Two-phase with home position in reverse operation	
		TRD-J□-RZVWS <small>Note 1</small>	Two-phase with home position and line driver	

Note: Consult your Koyo dealer for delivery period.

## ■ Model numbering system

TRD-J □ - RZ V W L - □

- Series
- Pulse/revolution
- Output signal  
S: One-phase/RZ: Two-phase with home position in normal operation
- Output type  
Blank: Totem-pole/V: Line driver
- Connection  
Blank: Rear cable  
W: Dust and splash proofed/C: Connector/CW: Dust and splash proofed with connector  
S: Side cable/WS: Dust and splash proofed with side cable
- Home position reverse operation symbol  
If output signal is RZ, model numbers with "L" are home position reverse operation type.
- (Available options)

Rotary Encoders

Incremental Type

TRD-S/SH

TRD-2E

TRD-N/NH

TRD-J

TRD-GK

Absolute Type

TRD-NA

TRD-K

TRD-KL

## ■ Pulse and frequencies

Pulse/revolution		10	30	40	50	60	100	120	200	240	300	360	400	500	600	750	1000
Max. response frequency (kHz)*		0.5	1.5	2	2.5	3	5	6	10	12	15	18	20	25	30	37.5	50
Applicable models	TRD-J□-S□	●	●	●	●	●	●	●	●	●	●	●	●	●	●	●	●
	TRD-J□-RZ□		●	●	●	●	●	●	●	●	●	●	●	●	●	●	●
	TRD-J□-RZV□		●	●	●	●	●	●	●	●	●	●	●	●	●	●	●

\* Maximum response frequency is defined by the following formula:  
 Maximum revolution speed = (Maximum response frequency/Pulse) × 60  
 The encoder does not respond to revolution faster than the maximum speed.

## ■ Electrical specifications

Model		TRD-J□-S□	TRD-J□-RZ□	TRD-J□-RZV□	
Power source	Power source voltage	4.75 to 30 VDC	4.75 to 30 VDC	4.75 to 5.25 VDC	
	Allowable ripple	3% rms max.	3% rms max.	3% rms max.	
	Current consumption (no load)	40 mA (See "Electrical Characteristics" .) max.	60 mA (See "Electrical Characteristics" .) max.	130 mA max.	
Output wave form	Output signal type	One-phase	Two-phase + home position	Two-phase + home position	
	Duty ratio	50 ± 25% (square wave)	50 ± 25% (square wave)	50 ± 25% (square wave)	
	Signal width at home position	—	50 to 150%	50 to 150%	
	Rise/Fall time	3 μs (Max. Cable 50 cm) max.	3 μs (Max. Cable 50 cm) max.	2 μs (Max. Cable 50 cm) max.	
Output	Output Type	Totem-pole	Totem-pole	Line-driver*	
	Output current	Outflow "H"	10 mA max.	10 mA max.	—
		Inflow "L"	30 mA max.	30 mA max.	—
	Output voltage	"H"	[(Load power voltage) – 2.5 V] min.	[(Load power voltage) – 2.5 V] min.	2.5 V max.
		"L"	0.4 V max.	0.4 V max.	0.5 V max.
	Output standard	TTL 5V	10TTL	10TTL	—
Load power voltage		30 VDC max.	30 VDC max.	—	

\* Equivalent to 26LS31  
 (Output signal is compatible to TTL)

## ■ Mechanical specifications

Initial torque	0.003 N•m (+20°C) max. (Dust and splash proofed: Min. 0.02 N•m)
Moment of inertia	2×10 <sup>-6</sup> kg•m <sup>2</sup>
Allowable load	Radial: 50 N
	Thrust: 30 N
Maximum allowable speed (Note 1)	5000 rpm (Dust and splash proofed: 3000 rpm)
Service life of bearing	5×10 <sup>8</sup> revolution (calculated value at the maximum load)
Cable	External diameter ø5 mm (W type: ø6 mm) 5-wire oil resistant PVC cable Nominal section area of core: 0.3 mm <sup>2</sup> (Line driver output: 8 cores, 0.14 mm <sup>2</sup> )
Weight	220 g (with 0.5 m cable) max.

Note 1: Highest speed that can support mechanical integrity of the encoder

## ■ Environmental requirements

Ambient temperature	-10 to +50°C
Storage temperature	-25 to +85°C
Operating humidity	35 to 85% RH (with no condensation)
Voltage withstand	500 VAC for one minute — (between terminals and case)
Insulation resistance	50 MΩ min.
Vibration resistance	Durable for one hour along three axes at 10 to 55 Hz with 0.75 mm amplitude
Shock resistance	11 ms with 490 m/s <sup>2</sup> applied three times along three axes
Protection	IP50: Dust proofed
	IP65: Dust and splash proofed

Totem-pole output **TRD-J**  **-S**  / **TRD-J**  **-RZ**

■ Channel timing chart

One-phase: **TRD-J**  **-S**

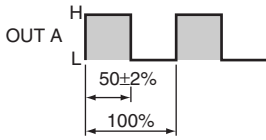

Two-phase with home position: **TRD-J**  **-RZ**

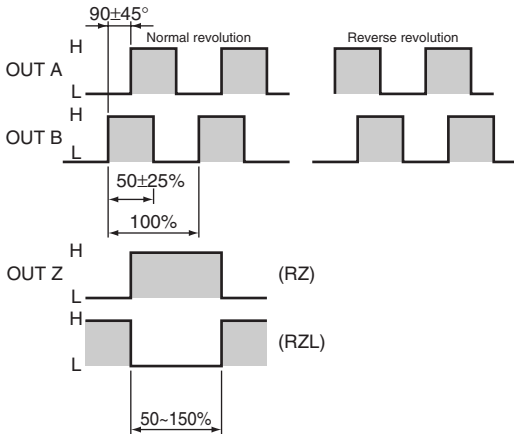

"Normal" means clockwise revolution viewed from the shaft.

■ Output circuit

Totem-pole output:

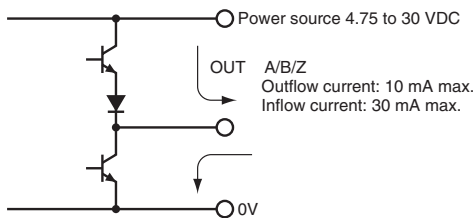

The above circuit can be applied to voltage output or open collector output as follows:

● Voltage output

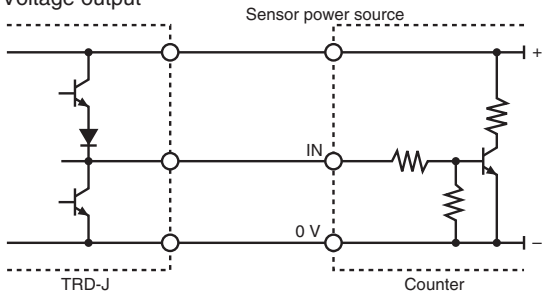

● Open collector output

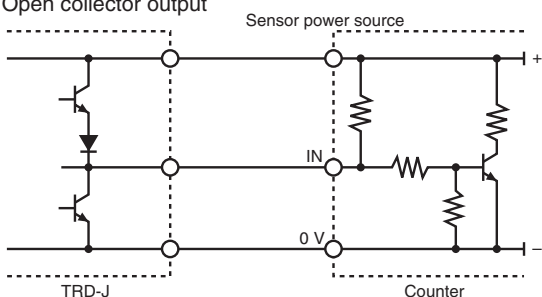

■ Electrical characteristics

Current consumption characteristics

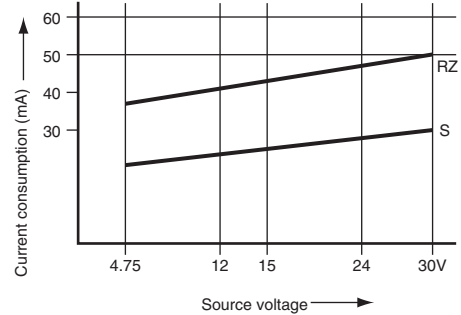

■ Terminal assignment

Shielded cable is not connected to the encoder body.

One-phase: **TRD-J**  **-S**

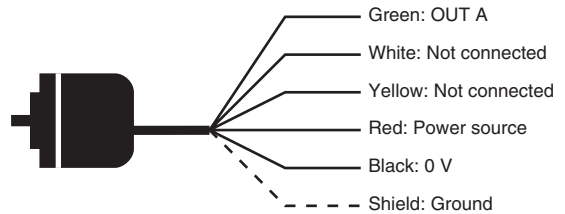

Pin out of connector

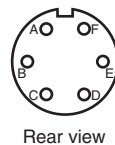

Pin code

- A: OUT A
- B: Not connected
- C: Not connected
- D: Power source
- E: 0V
- F: Not connected

Two-phase with home position: **TRD-J**  **-RZ**

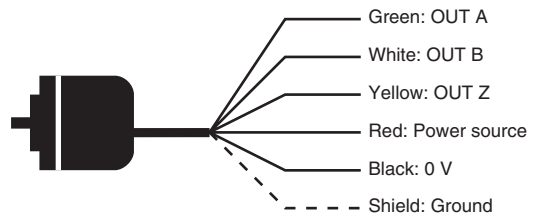

Pin out of connector

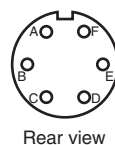

Pin code

- A: OUT A
- B: OUT B
- C: OUT Z
- D: Power source
- E: 0 V
- F: Not connected

Incremental Type

TRD-S/SH

TRD-2E

TRD-N/NH

TRD-J

TRD-GK

Absolute Type

TRD-NA

TRD-K

TRD-KL

## Line driver TRD-J -RZV

### Channel timing chart

Two-phase with home position: TRD-J  -RZV

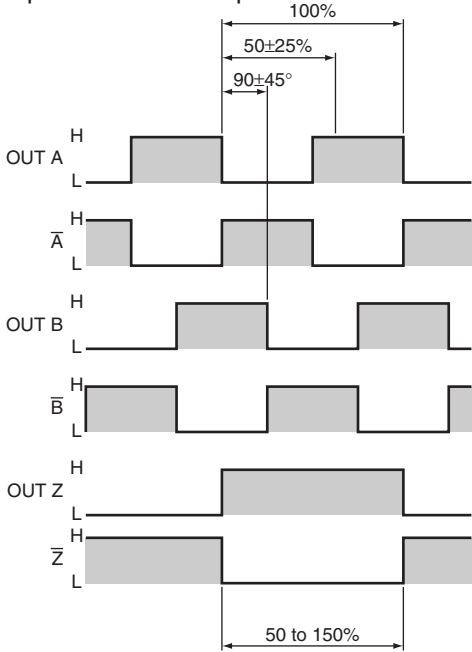

"Normal" means clockwise revolution viewed from the shaft.

### Output circuit

Line driver Output

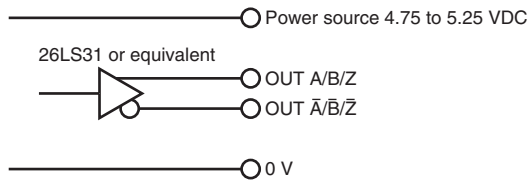

- The line driver can use a RS-422A compliant twisted pair cable of up to 1,200 m.

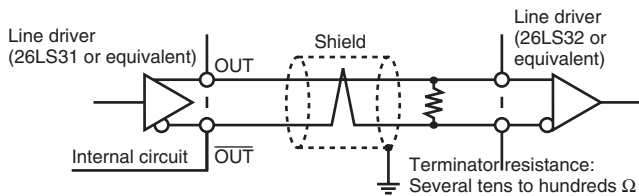

- Output signal turns to "H" level when the cable or connector is disconnected.

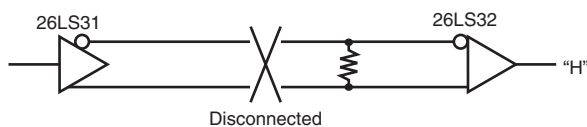

### Terminal assignment

Shielded cable is not connected to

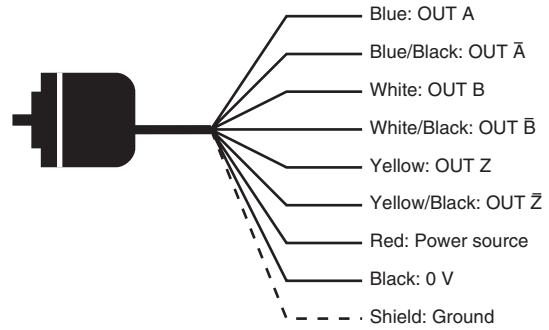

Pin out of connector

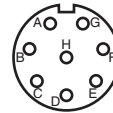

Rear view

Pin code

- A: OUT A
- B: OUT A-bar
- C: OUT B
- D: OUT B-bar
- E: OUT Z
- F: OUT Z-bar
- G: Power source
- H: 0 V

External Dimensions

(in mm)

● With side cable

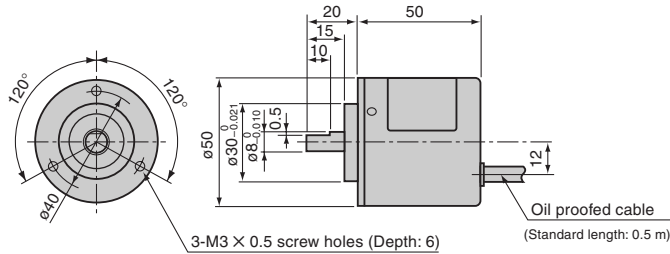

● Dust and splash proofed (W)

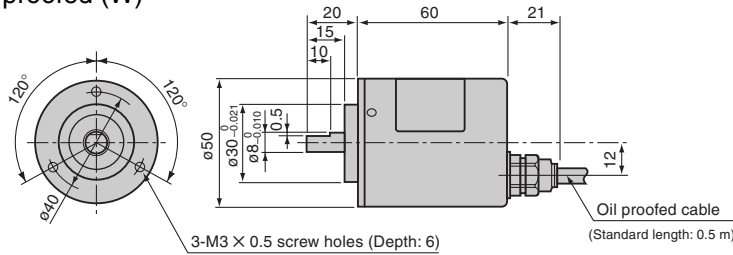

● With connector (C)

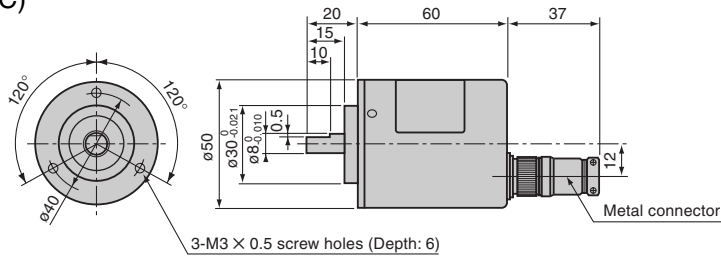

Model numbers of connectors

- Totem-pole (S□/RZ□)
    - Body: R03-R6F
    - Cable: R03-PB6M (Attached)
  - Line driver (RZV□)
    - Body: R03-R8F
    - Cable: R03-PB8M (Attached)
    - (made by Tajima Musen)
- \* Section area: Max. 0.3 mm<sup>2</sup>  
Diameter of cable duct : ø6.2

● Dust and splash proofed with connector (CW)

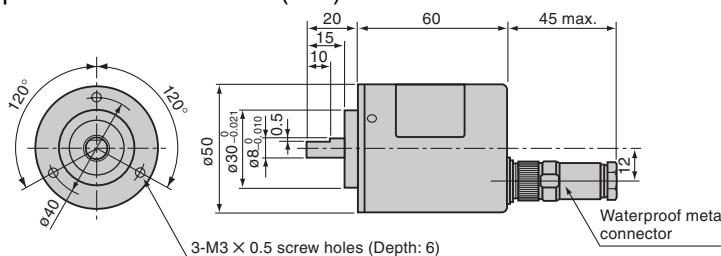

Model numbers of connectors

- Totem-pole (S□/RZ□)
    - Body: R04-R6F
    - Cable: R04-P6M (Attached)
  - Line driver (RZV□)
    - Body: R04-R8F
    - Cable: R04-P8M (Attached)
    - (made by Tajima Musen)
- \* Section area: Max. 0.3 mm<sup>2</sup>  
Diameter of cable duct : ø6.2

● With side cable (S)

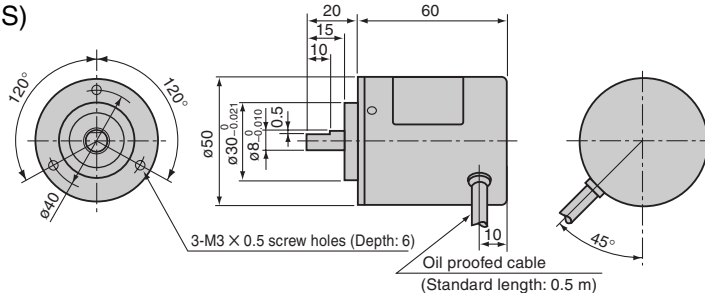

● Dust and splash proofed with side cable (WS)

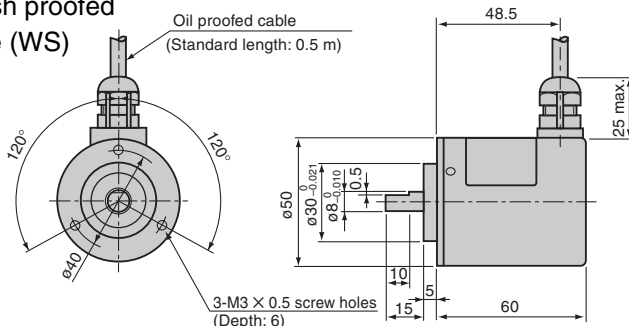

Rotary Encoders

Incremental Type

TRD-S/SH

TRD-2E

TRD-N/NH

TRD-J

TRD-GK

Absolute Type

TRD-NA

TRD-K

TRD-KL